



Since 1961
GEMM
Windows & Doors
A better outlook on life

LUMI

GLAZING SYSTEM CATALOGUE

LUMI GLAZED SCREENS AND DOORS



LUMI means functional and decorative internal glazing, adapted to the individual design. It acts as a divider or space separation into separate zones without restricting light. An aluminium structure in matt black or natural anode, filled with glass (transparent, frosted, coloured, wired) or furniture board, optically enlarges the interior and provides additional light and soundproofing.

The system allows many options of installation: screens, doors in a frame, or partition walls with hinged or sliding doors in various configurations. A multitude of solutions and the ability to adapt the space to specific conditions and requirements let you create unique, fully personalized projects.

CONTENTS

[1]	GLAZING WITH HINGED DOORS	2
[2]	GLAZING WITH SLIDING DOORS	8
[3]	INTERNAL SCREENS	14
[4]	DOOR IN A FRAME	19
[5]	SYSTEM COMPONENTS	24

[1] GLAZING WITH HINGED DOORS



Aluminium construction filled with glass or board, with hinged doors (single or double) in combination with upper transom and side fixed panels, in many configurations. The construction maximum height is 3 m. The length of the entire installation cannot exceed 4 m, and the maximum width of a single fixed panel or hinged doors is 1 m. The maximum height of the transom - 1 m and length - 2 m.

It is possible to make any divisions of the panel filling, horizontally and vertically. In panels higher than 2 m, at least one horizontal division should be made, in order to make the installation rigid. A specially designed vertical handle in three lengths is available for hinged doors. A door handle stylistically matched to the entire structure is on offer as well.

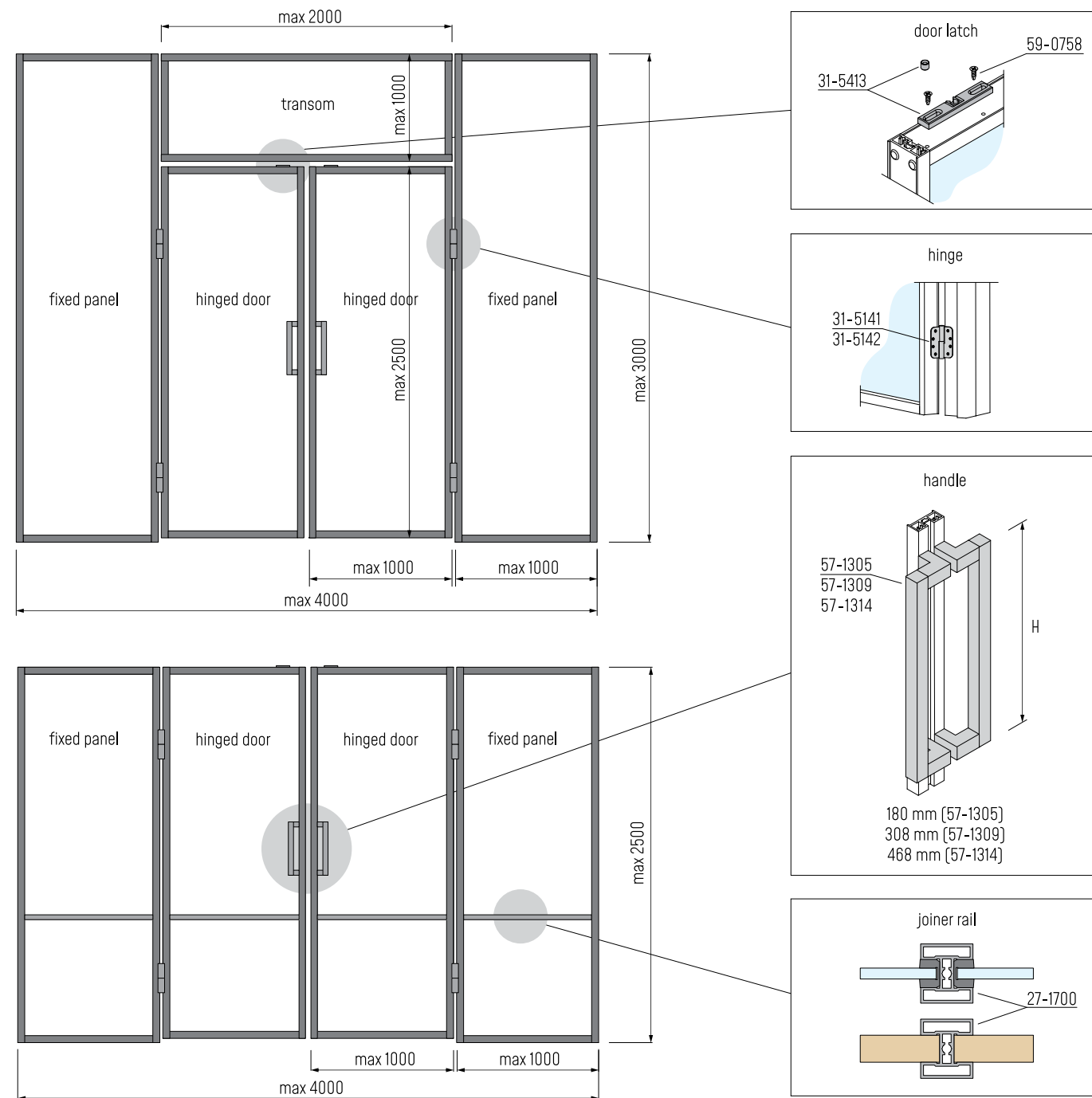

[CONFIGURATION EXAMPLES]

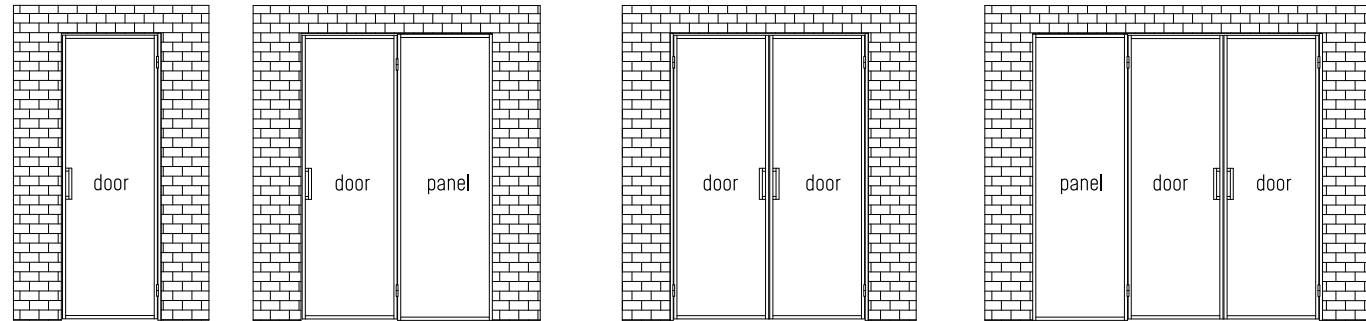
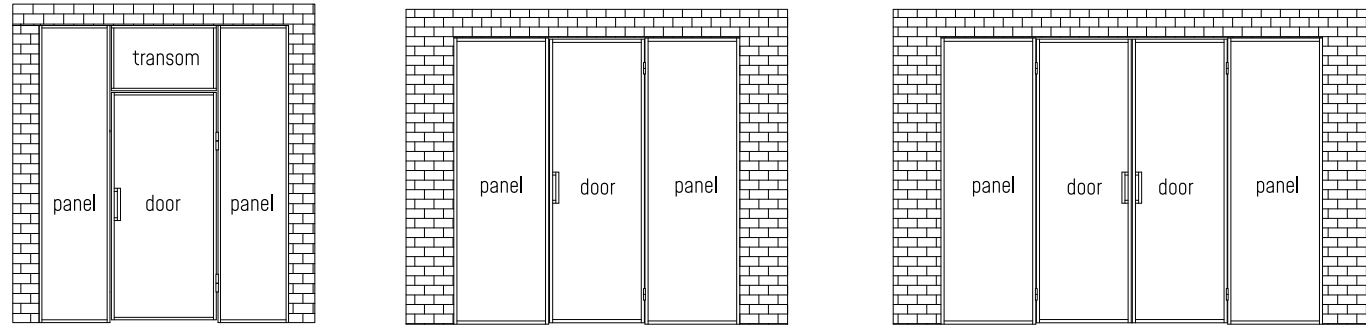
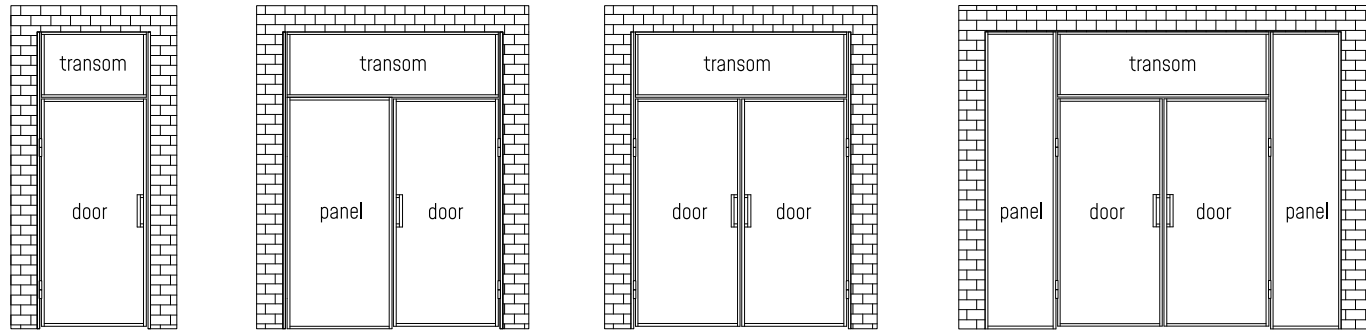

[EXAMPLES OF DIVISIONS AND FILLINGS]

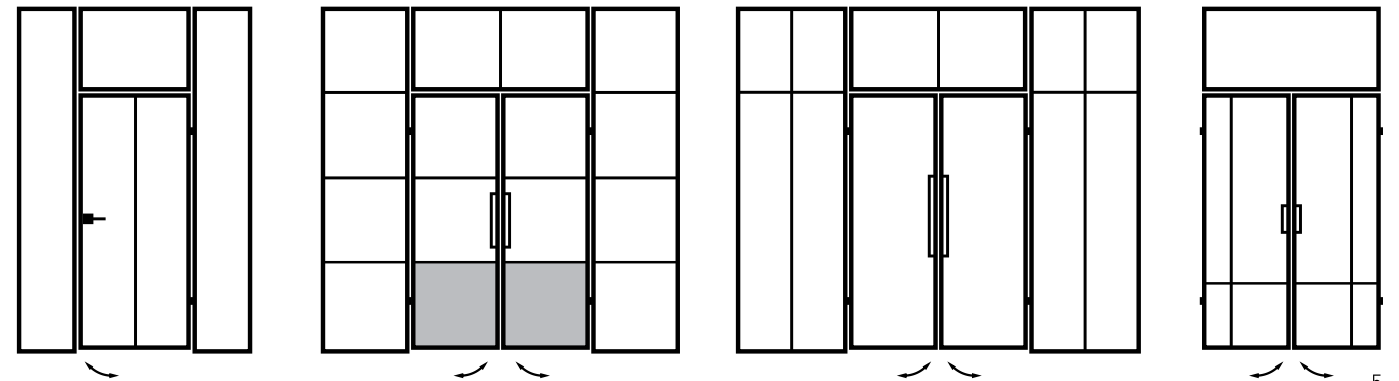
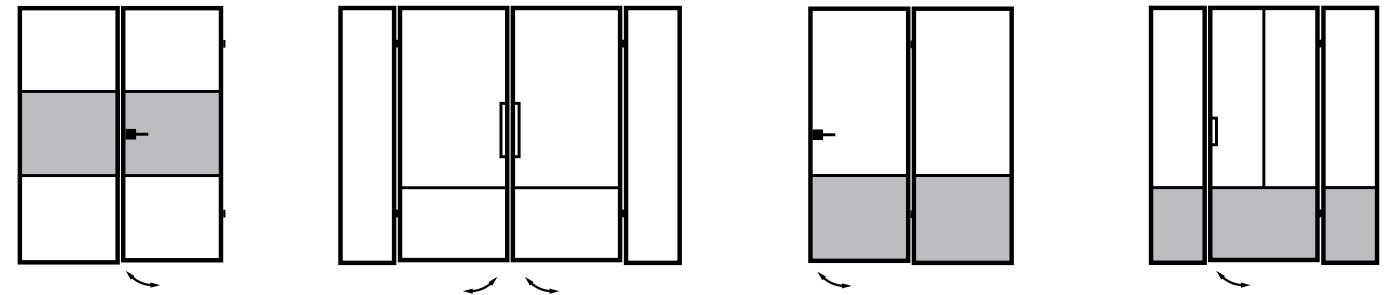
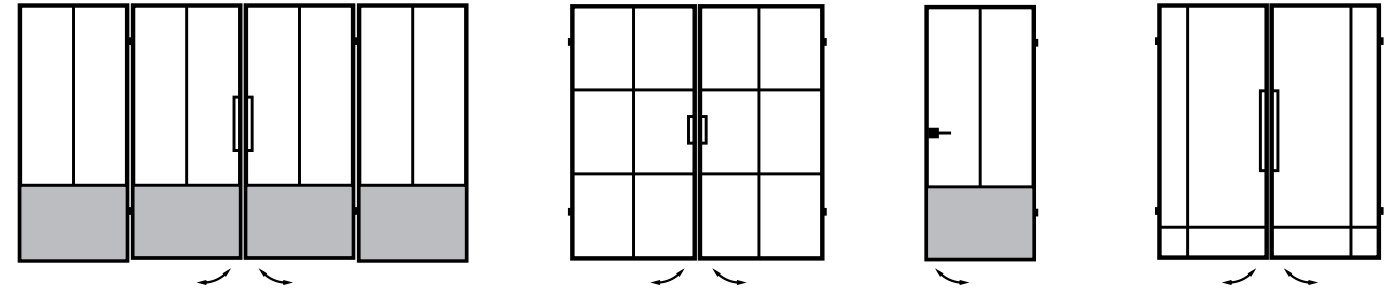

[TECHNICAL DETAILS]

TRANSOM WITH FIXED PANEL

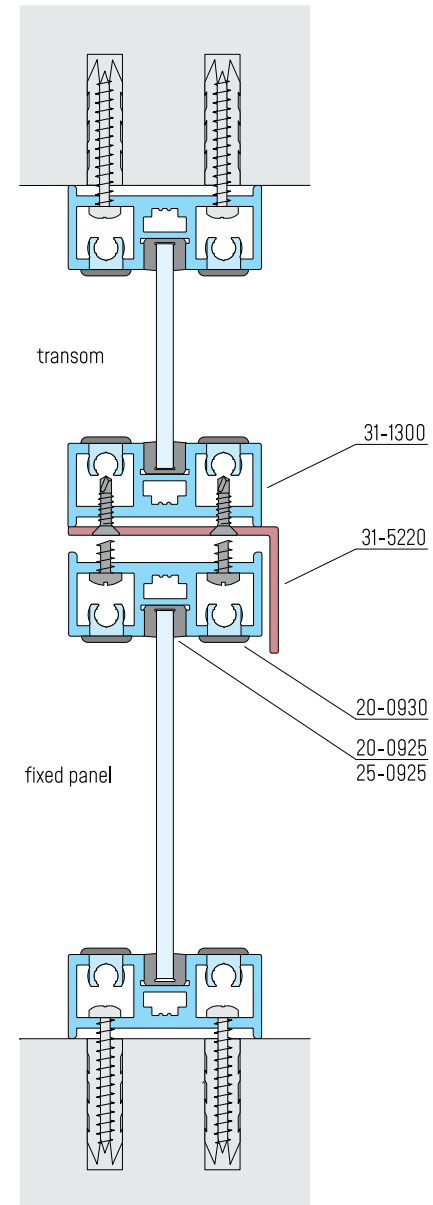

TRANSOM WITH HINGED DOORS

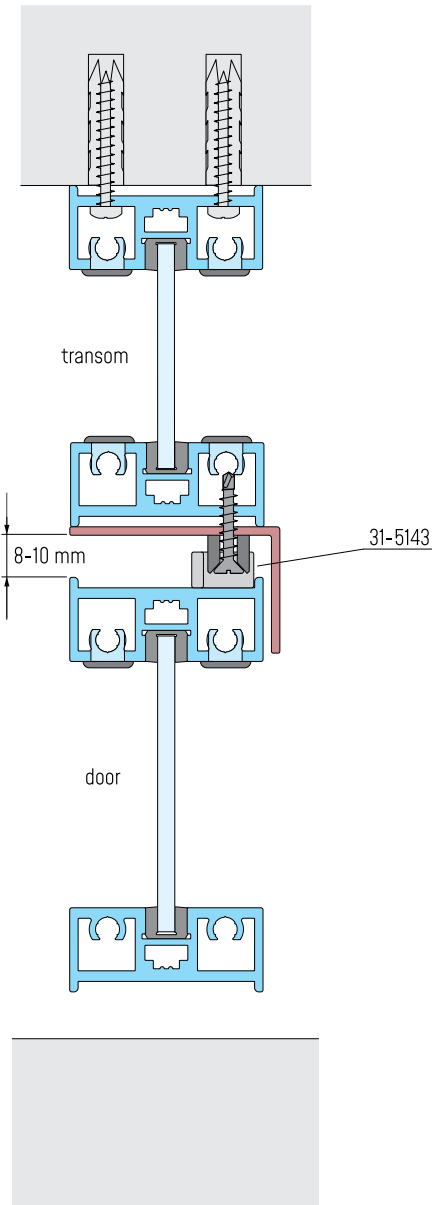

FIXED PANEL

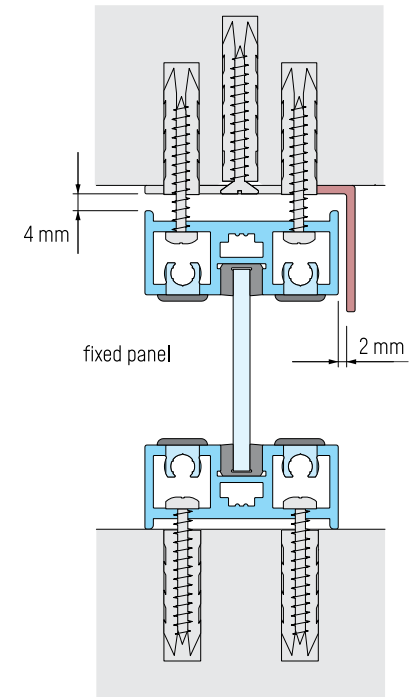

JOINING PROFILES IN THE CORNER

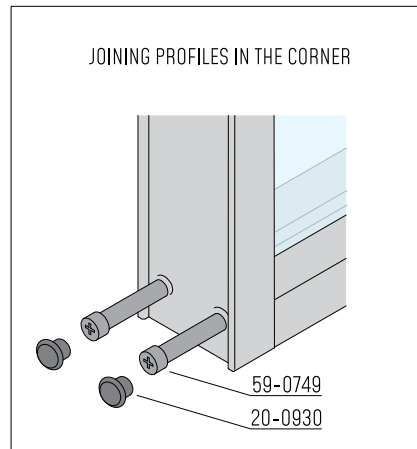

[TECHNICAL DETAILS]

FIXED PANEL ADJUSTMENT OPTION

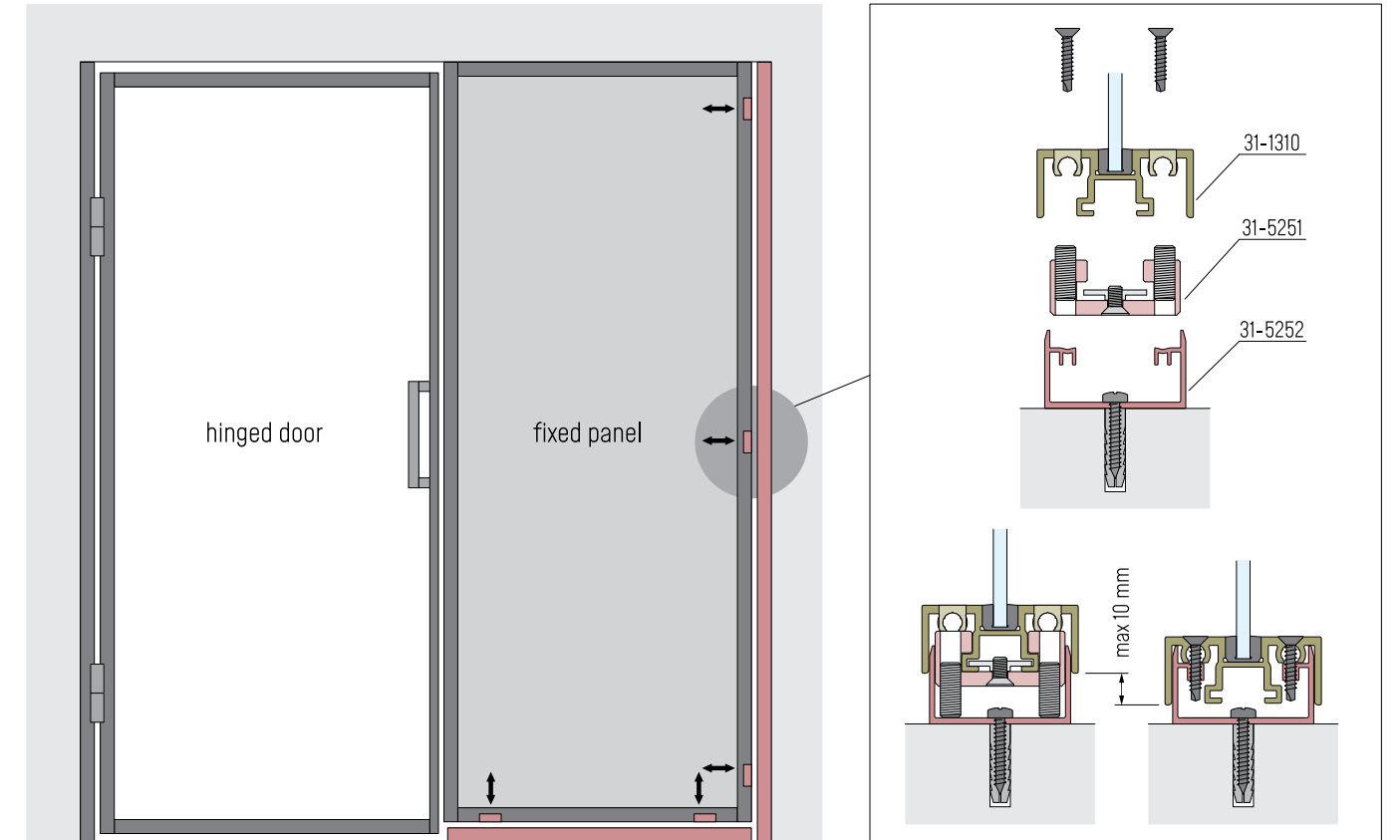

adjustment c-channel bar

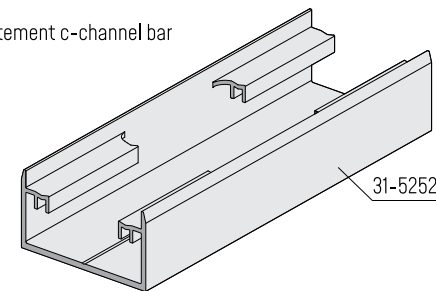

adjustment insert

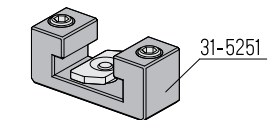

masking plate

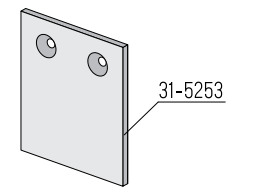

[2] GLAZING WITH SLIDING DOORS



Single or double aluminium sliding doors, filled with glass or board, in combination with fixed side panels in various configurations, give the room an industrial feel.

The maximum height of the installation is 3 m and the length is 5 m. The width cannot exceed 1 m for fixed panel and 1,5 m for sliding door. Horizontal and vertical divisions can be made in any arrangement for both.

A special handle available in three lengths has been designed for the doors. Construction components are available in two colours: black matt and natural anode.

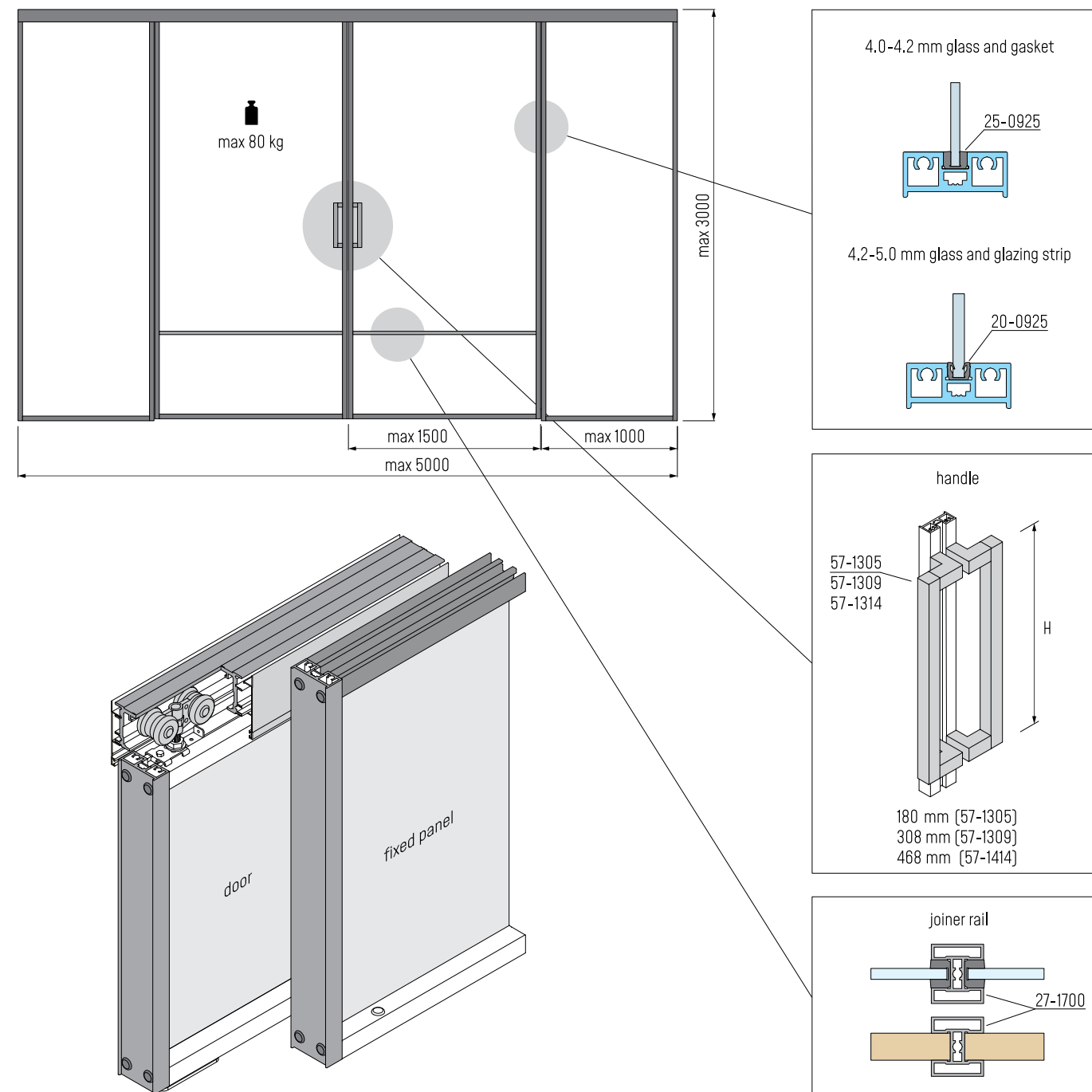

[CONFIGURATION EXAMPLES]

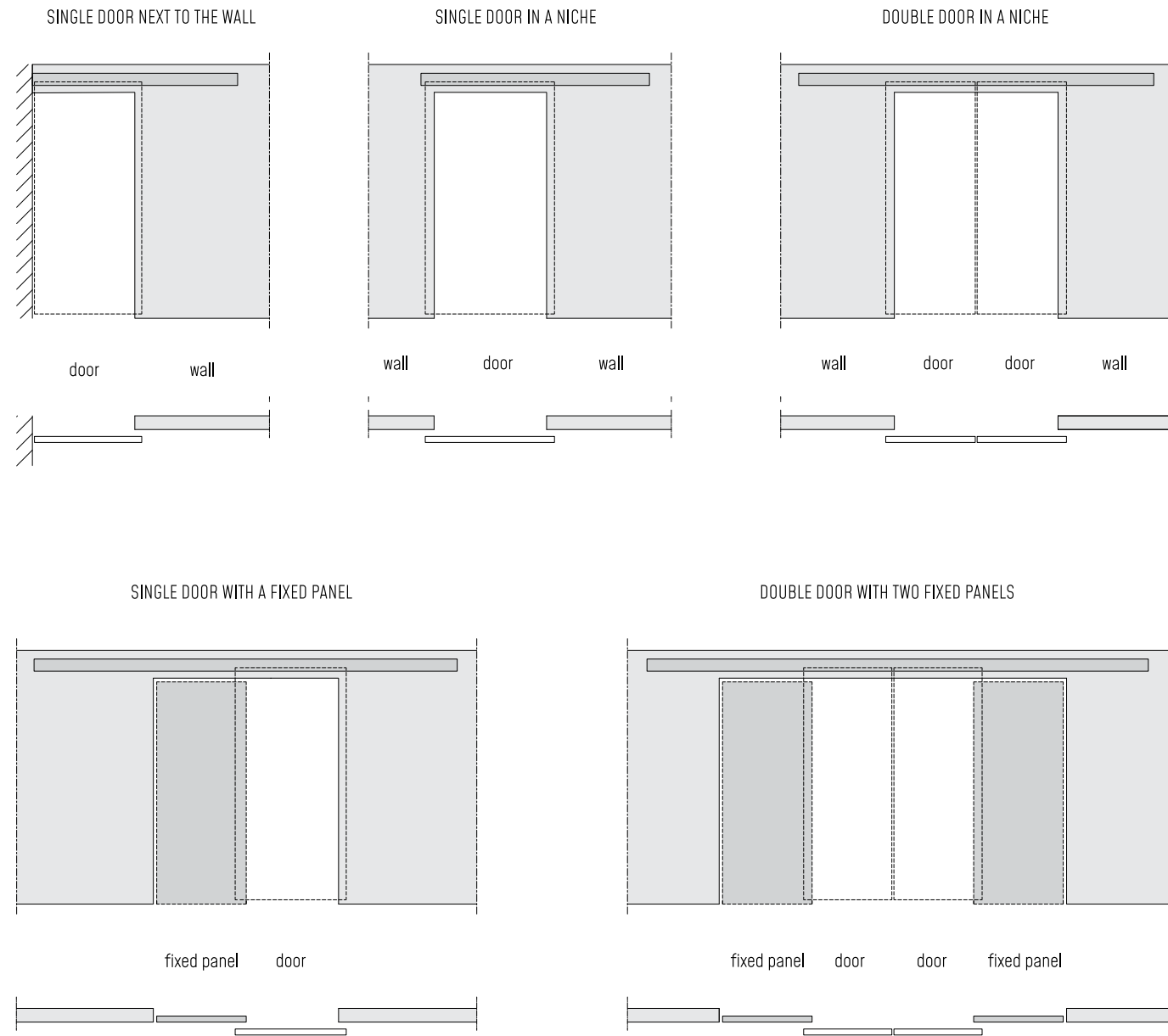

[EXAMPLES OF DIVISIONS AND FILLINGS]

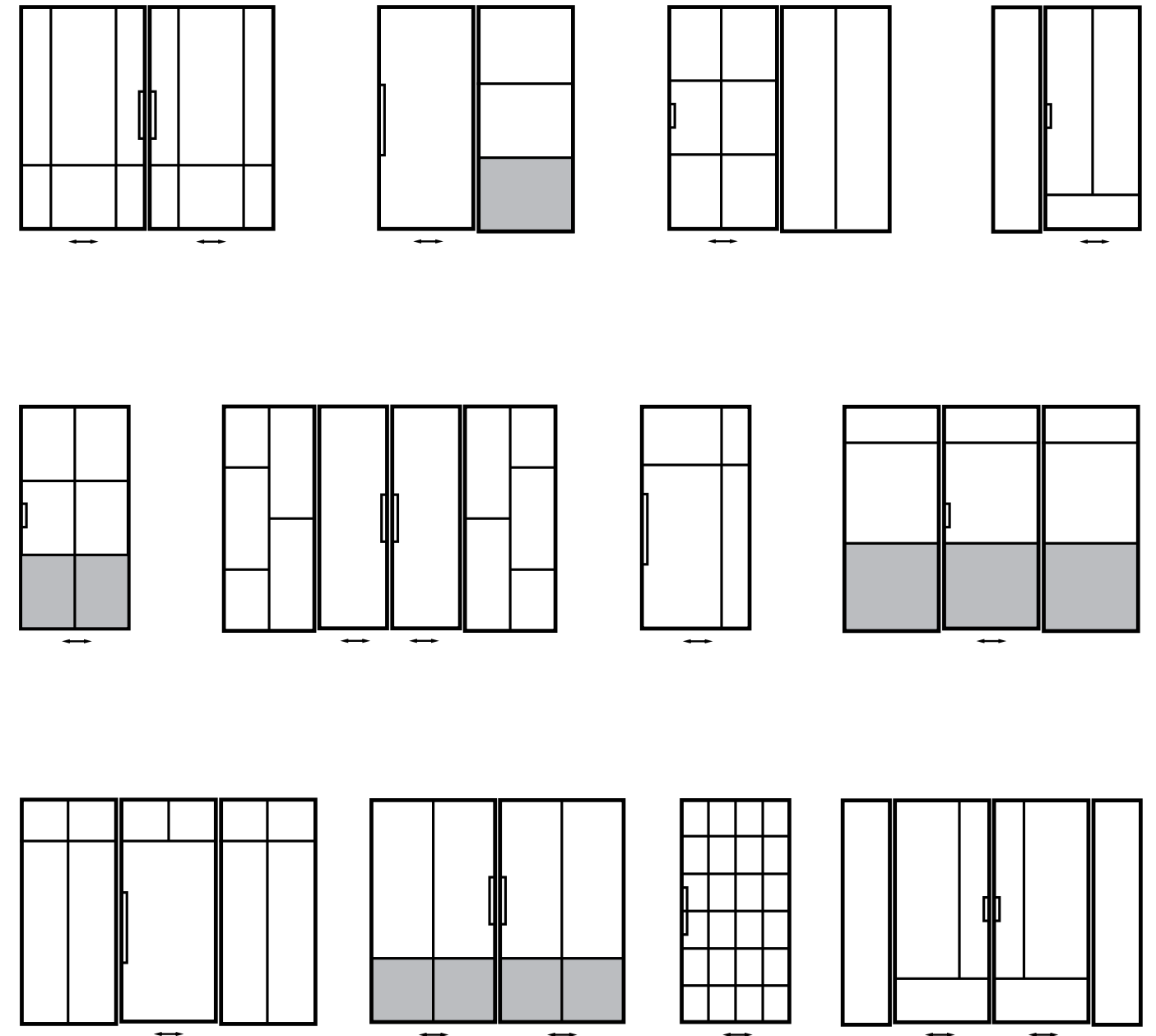

[TECHNICAL DETAILS]

FIXED TO THE CEILING

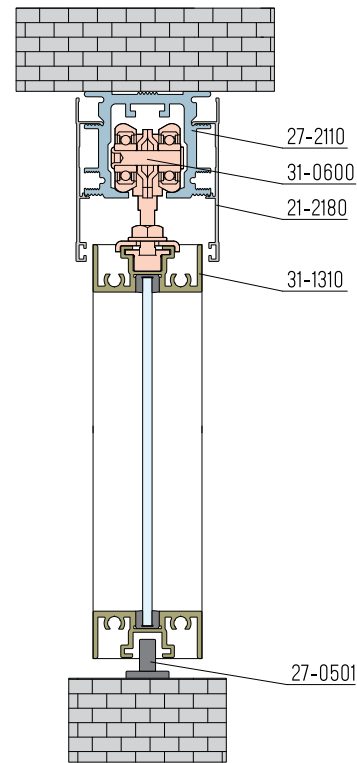

FIXED TO THE WALL

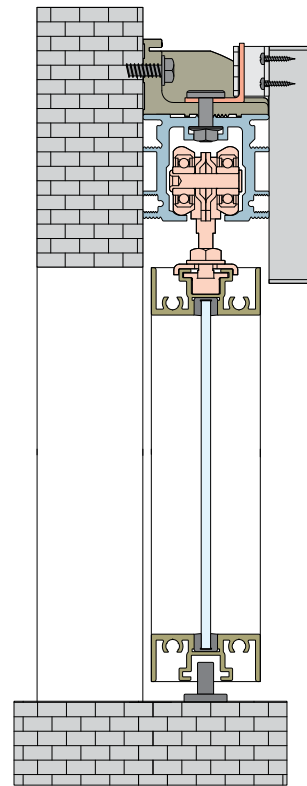

SLIDING DOOR AND FIXED PANEL

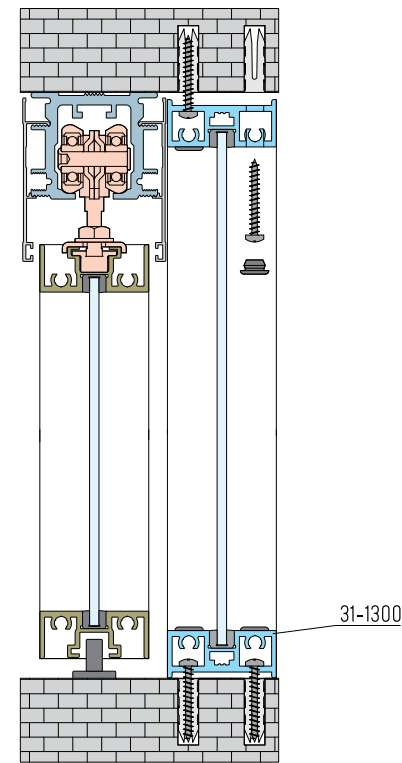

TOP TRACK WITH ROLLER AND AIR SPRING

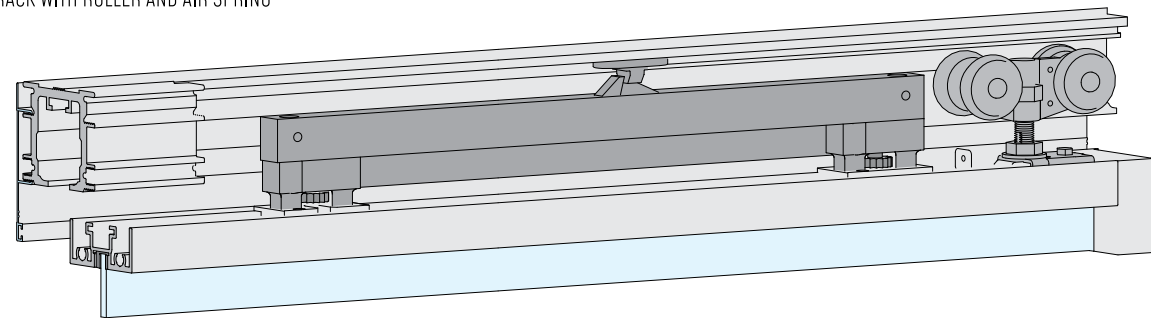

[TECHNICAL DETAILS]

FIXED PANEL ADJUSTMENT OPTION

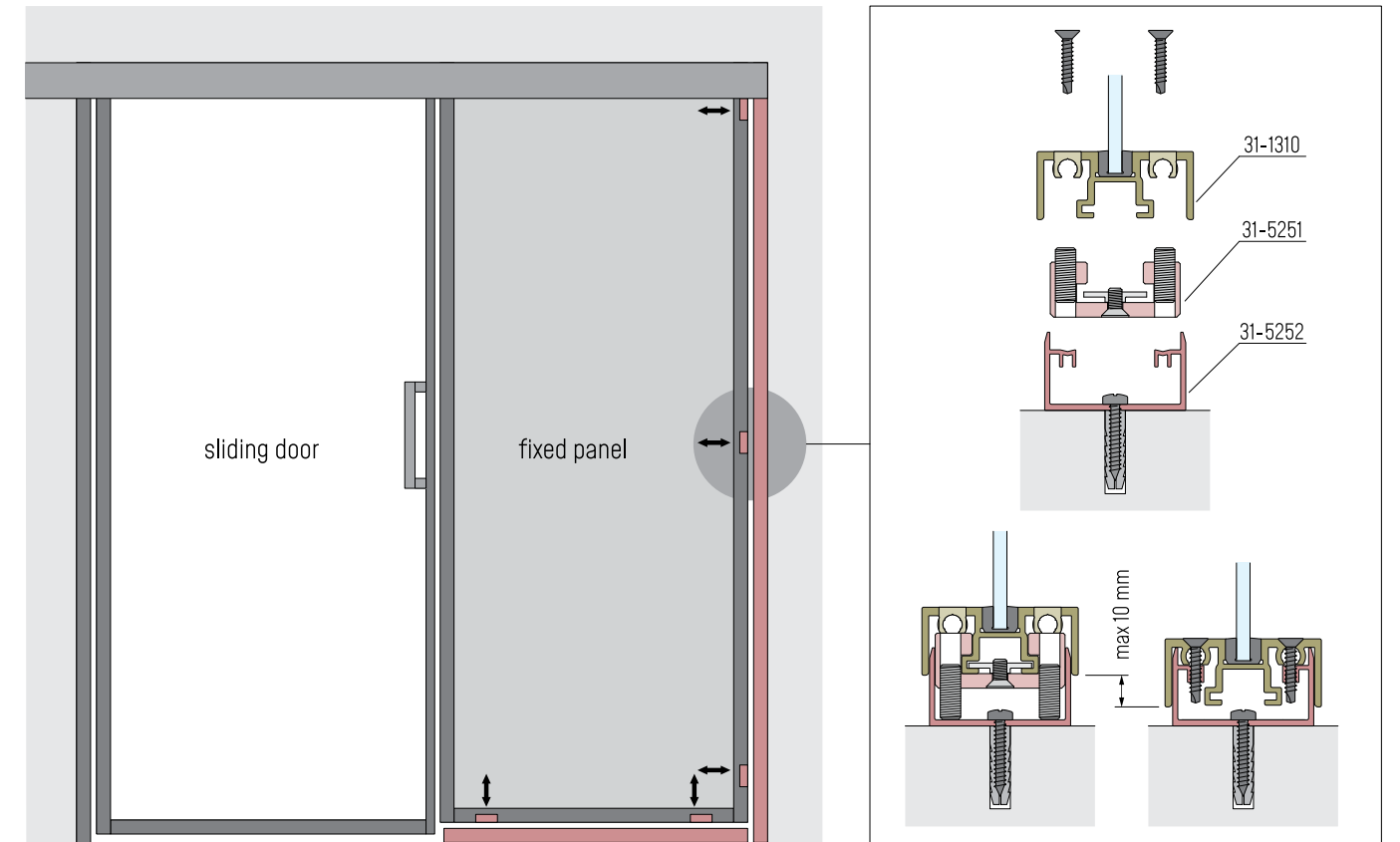

adjustment c-channel bar

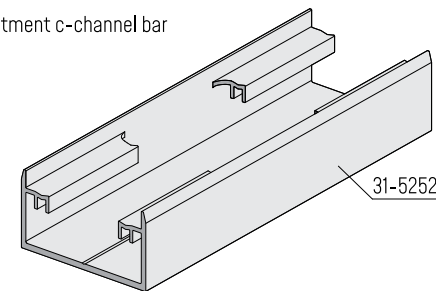

adjustment insert

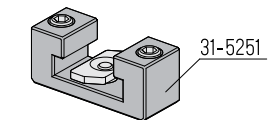

masking plate

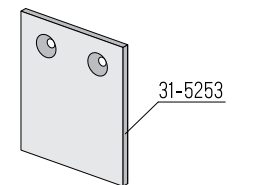

[3] INTERNAL SCREENS



Glazed internal screens with mullions, functioning as subtle partition walls. They provide additional light, soundproofing and optically enlarge the interior, giving the space separate functions. They stand out with their simple, minimalist form and lightness.

The screens are build of fixed panels only, based on subtle aluminium profiles in a black matt or natural anode finishing. The screens maximum height is 2 m, and the width is 2.75 m. Unlimited vertical and horizontal divisions of the screens and the multitude of design options provide wide possibilities of arranging the interior.

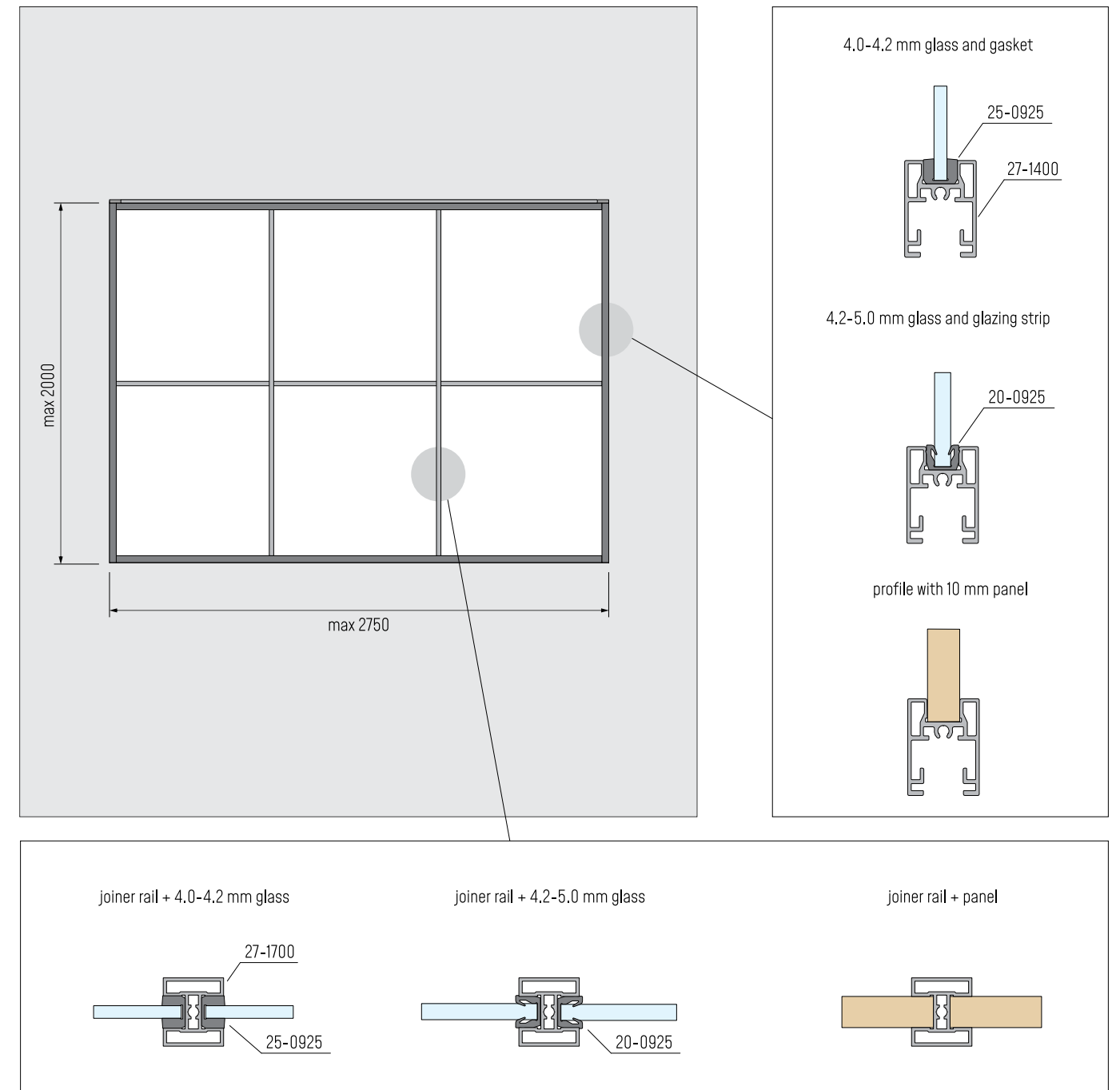

[CONFIGURATION EXAMPLES]

OPEN SCREEN

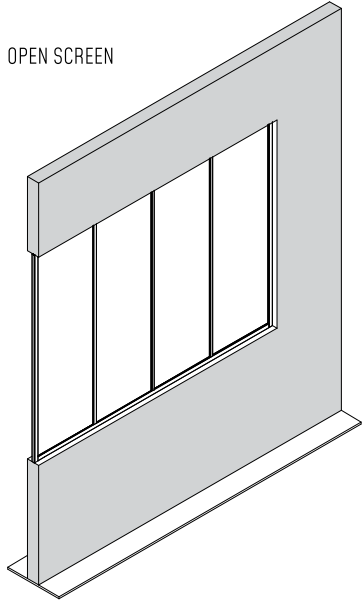

CROSS SCREEN

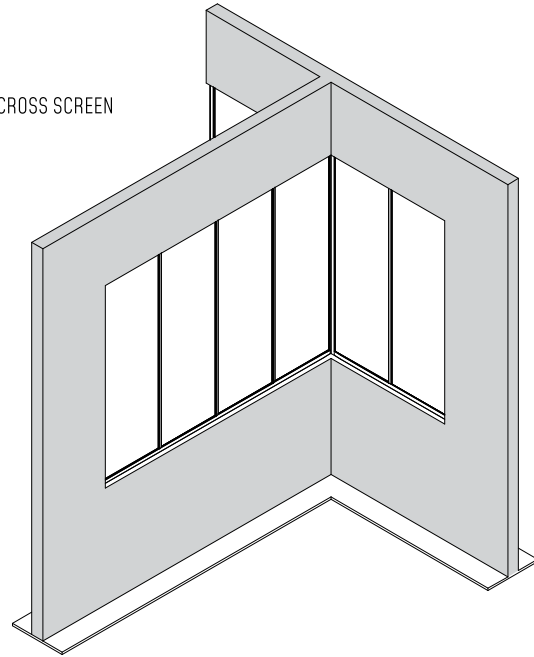

CORNER SCREEN

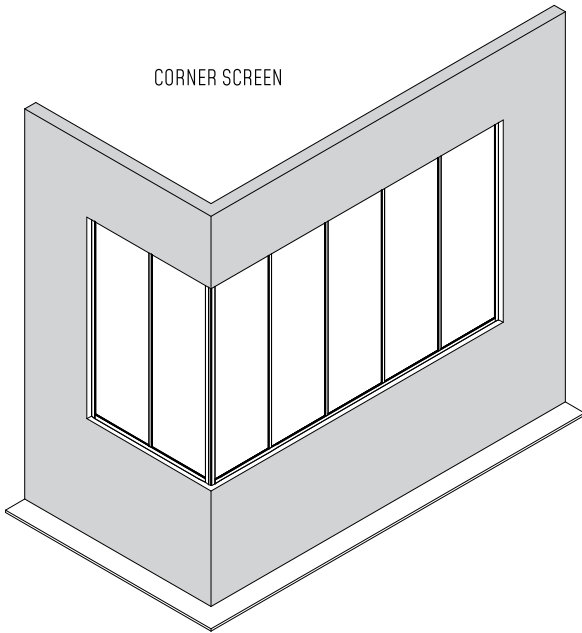

CLOSED SCREEN

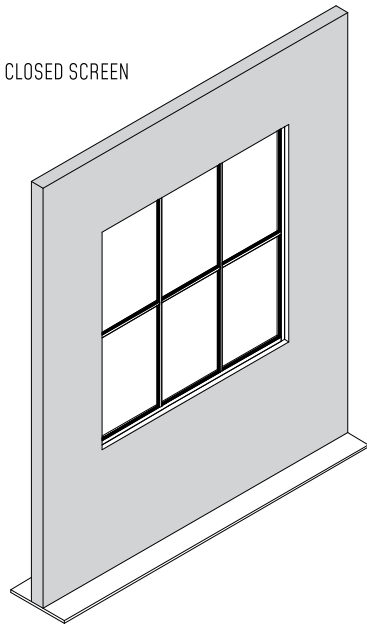

[EXAMPLES OF DIVISIONS AND FILLINGS]

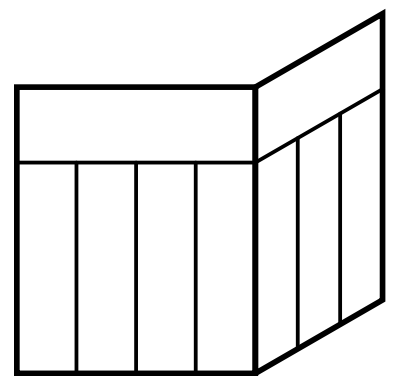
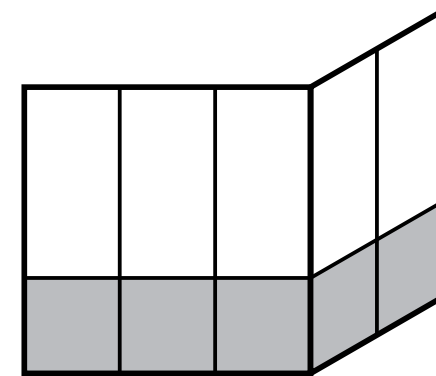
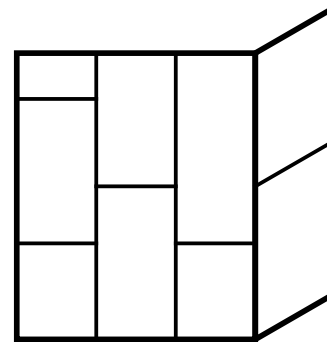
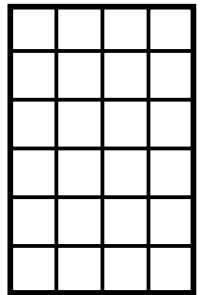
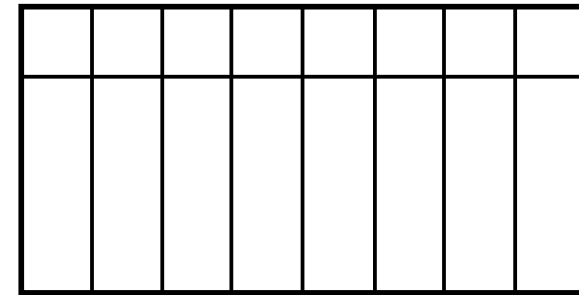
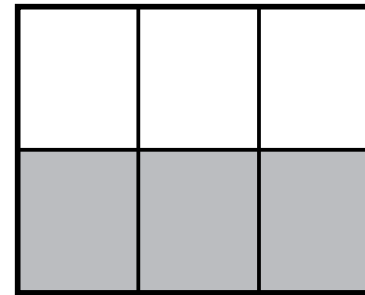
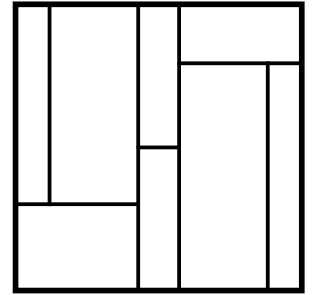
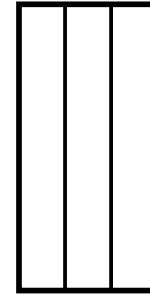
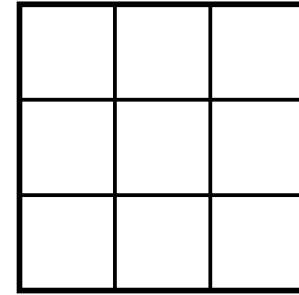
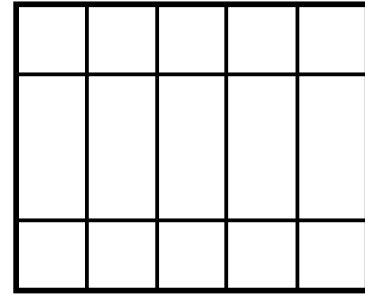

[TECHNICAL DETAILS]

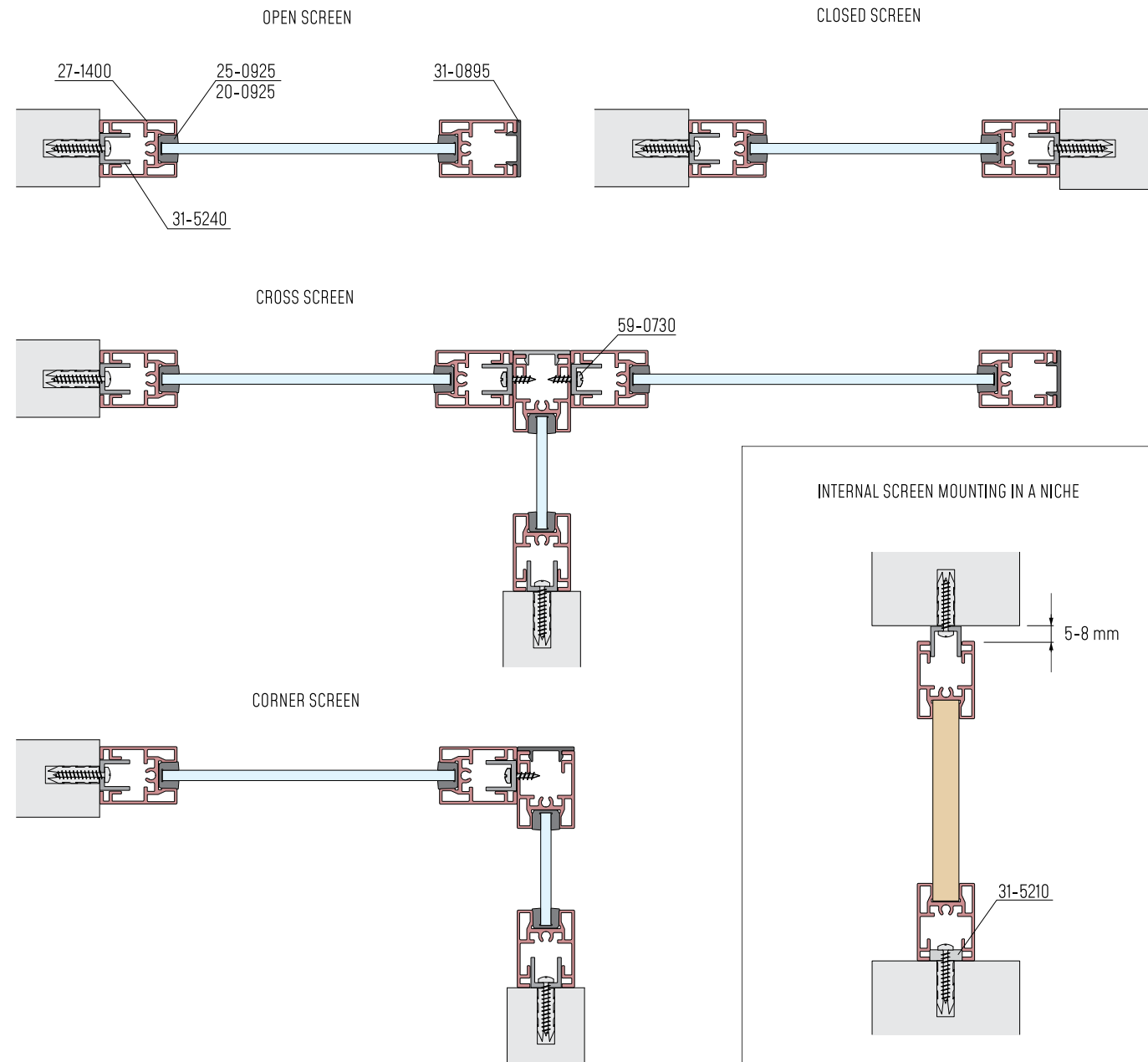

[4] DOOR IN A FRAME



Glazed interior doors in an aluminium frame. A single, hinged leaf in a frame, with a grip or door handle. The variety of divisions and fillings allows the door to be adapted to all requirements, giving the interior a loft look.

Doors with a 1 m maximum width and a height of 2.5 m, based on an aluminium profile in black matt or natural anode, with option of horizontal and vertical divisions. The door filling can be glass (transparent, frosted, coloured, wired), a mirror or a board. The right or left door version is available. For the convenience of installation, two types of door frames have been designed: fixed and adjustable width.

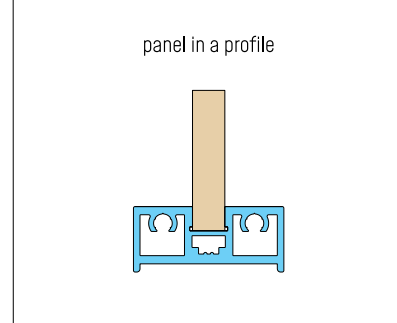
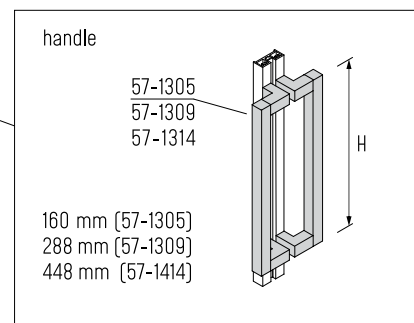
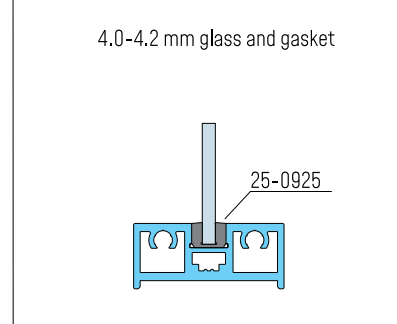
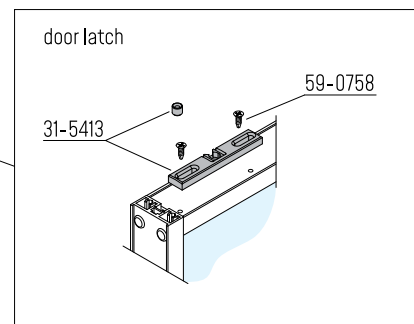
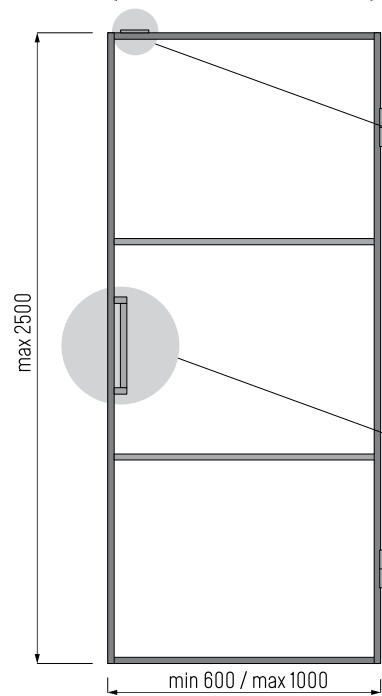
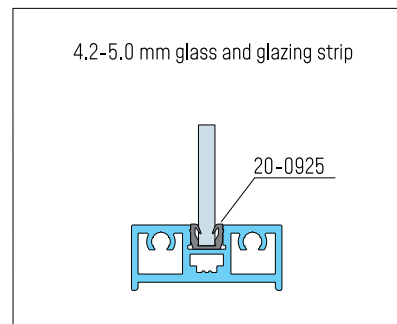
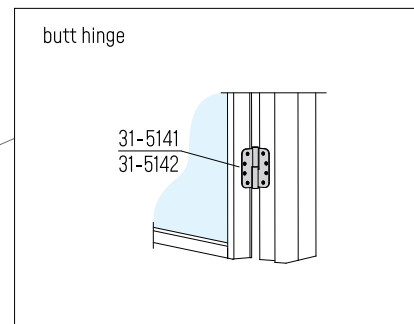
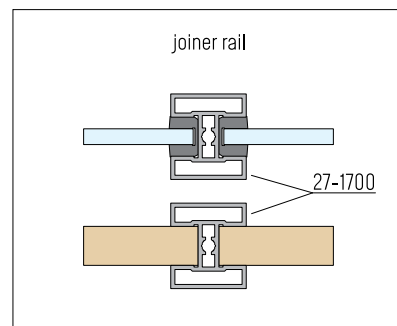
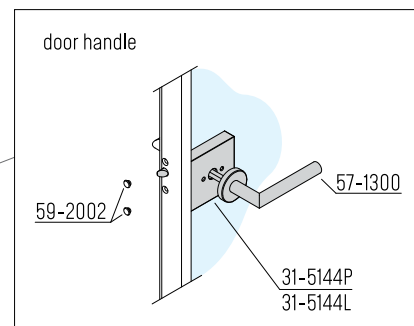
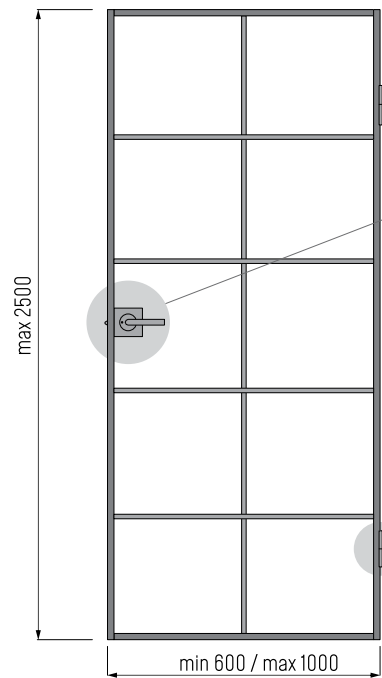

[EXAMPLES OF DIVISIONS AND FILLINGS]

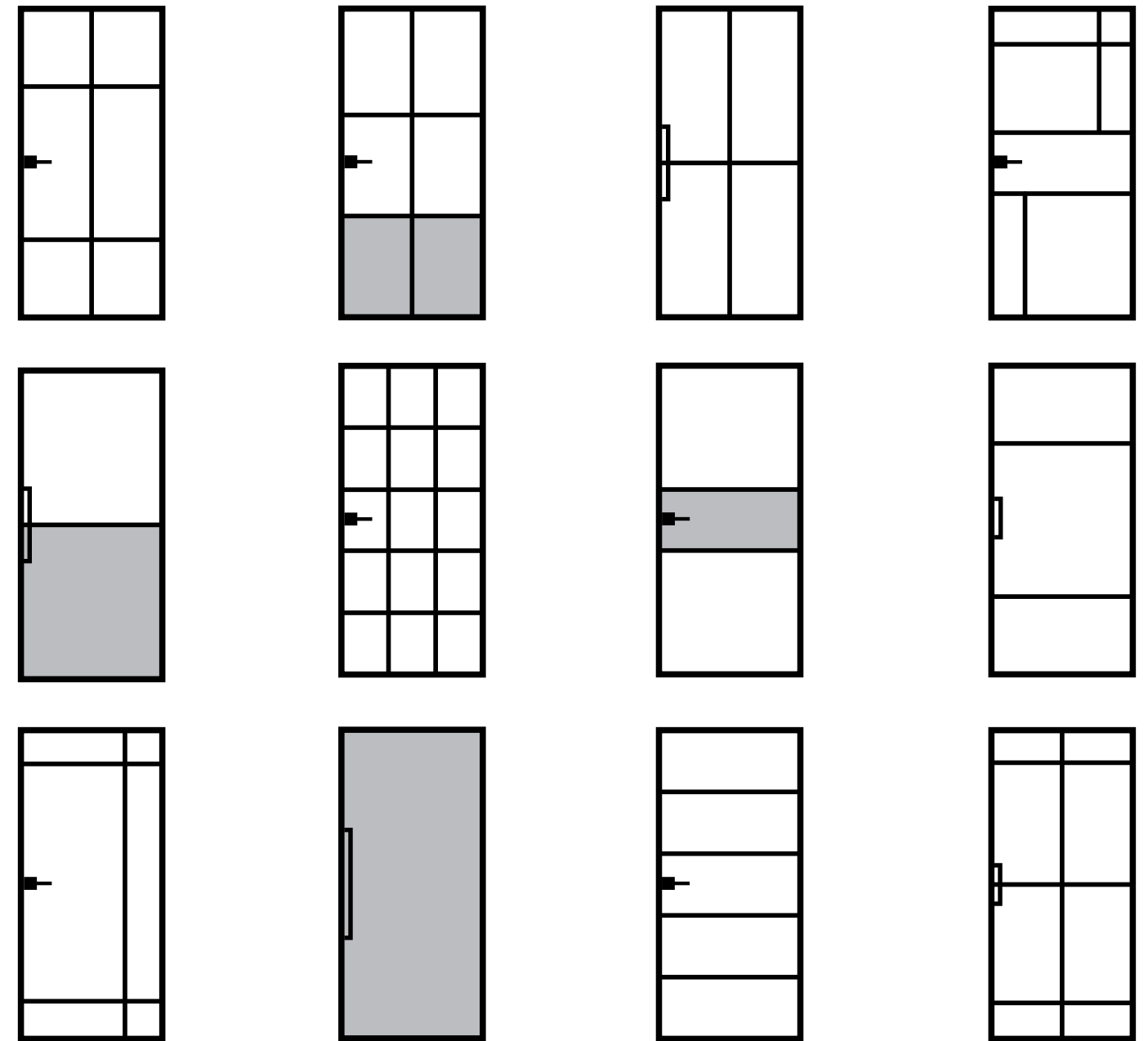

[TECHNICAL DETAILS]

FIXED DOOR FRAME

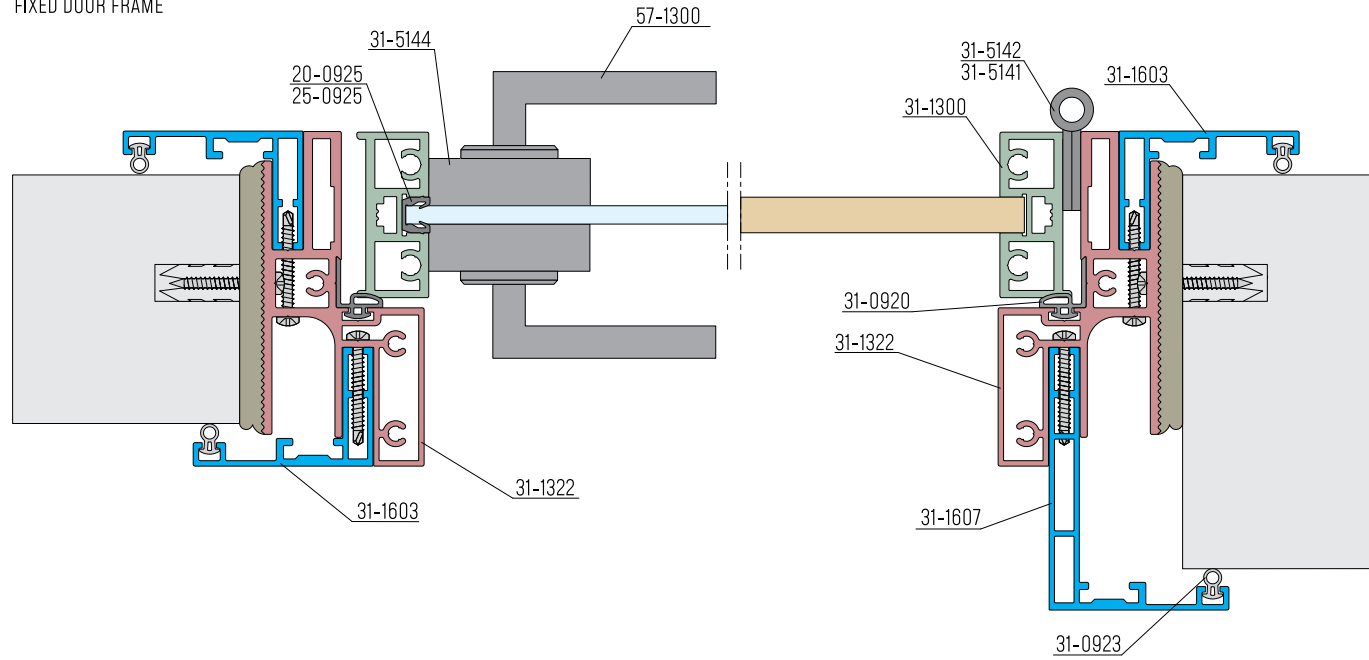

ADJUSTABLE DOOR FRAME

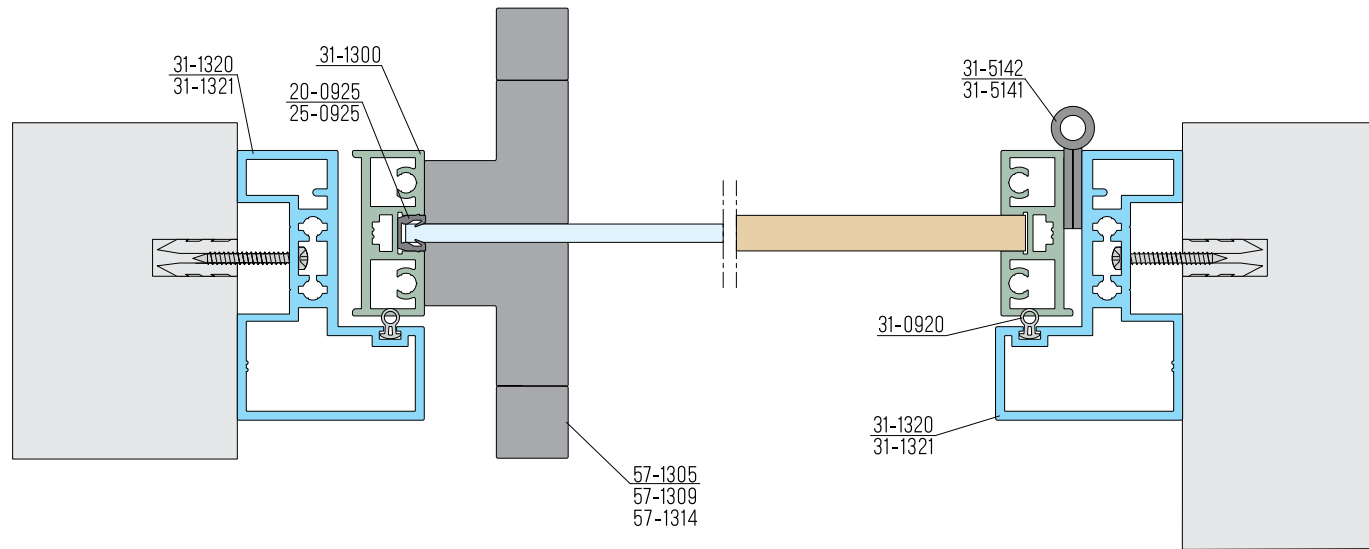

[TECHNICAL DETAILS]

ADJUSTABLE DOOR FRAME - RANGES

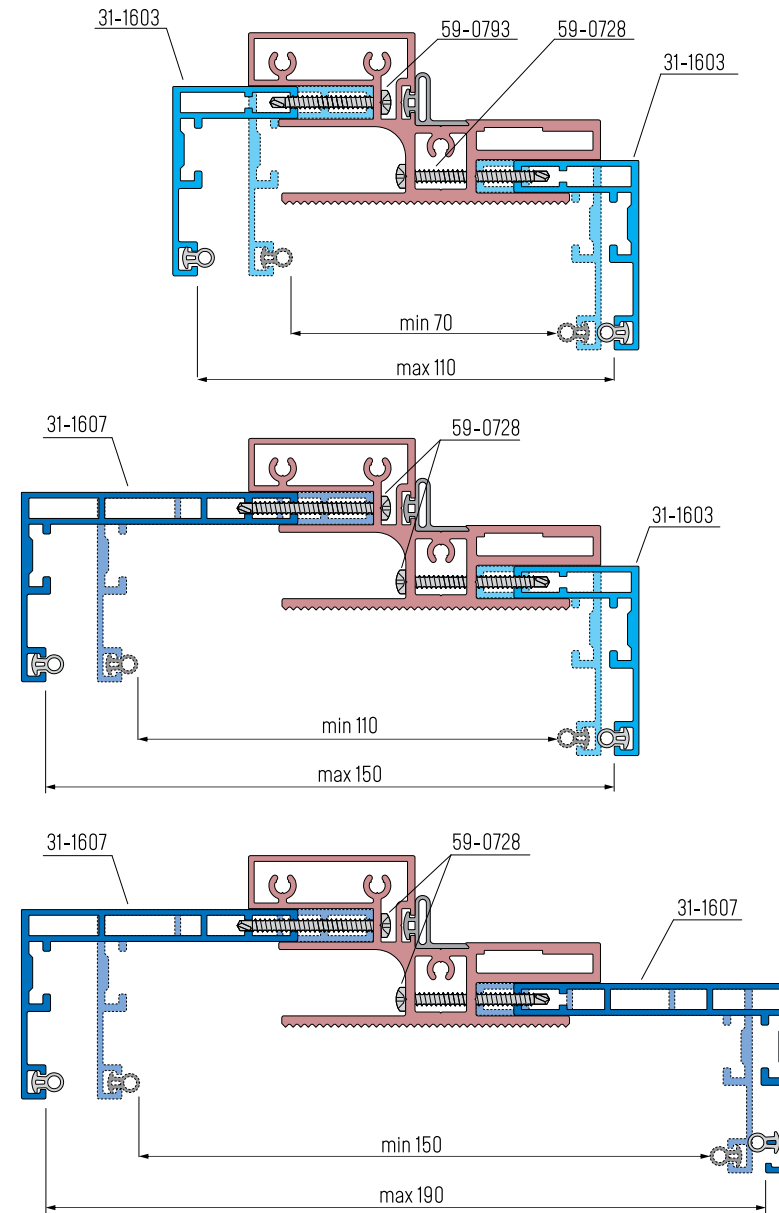

CASING PROFILES

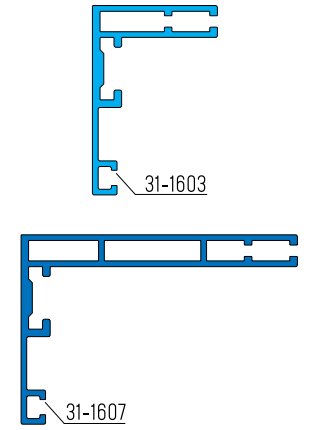

FRAME ASSEMBLING

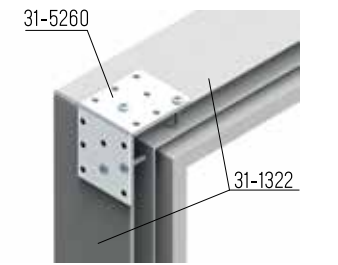

door frame



casing

[5] SYSTEM COMPONENTS

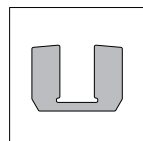

20-0925
GLAZIN STRIP
CM, PR

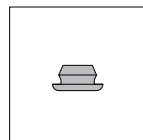

20-0930
PLUG
AN, CZ

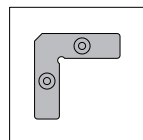

21-1301
SMALL FIXING BRACKET

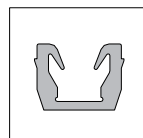

25-0925
AL25 SERIES 4 MM GASKET
CM, PR

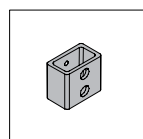

26-0181
AL26 MASKING STRIP HOLDER

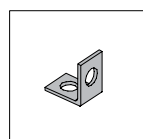

26-0182
AL26 MASKING STRIP CATCH

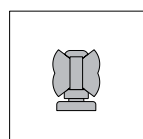

27-0501
AL27 BOTTOM SLIDING GUIDE
CZ, SZ

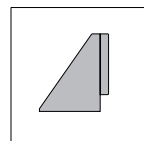

27-0980
AL27 BOTTOM STOPPER
AN, CM

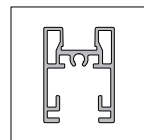

27-1400
AL27 RAIL, 2750 MM
AN, CM

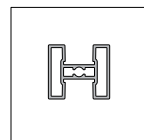

27-1700
AL27 SINGLE DOOR JOINER RAIL, 2750 MM
AN, CM

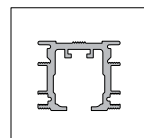

27-2110
AL27-2 TOP TRACK 2, 5000 MM

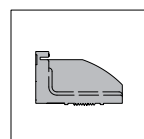

27-2130
AL27-2 ANGLE BRACKET

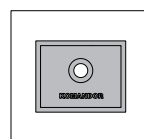

27-2131
AL27-2 SPACER WASHER

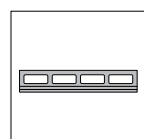

27-2140
AL27-2 SPACER INSERT

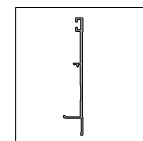

27-2180
AL27-2 CEILING MASKING STRIP, 5000 MM
AN, CM

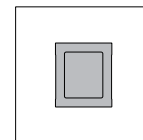

27-2181
AL27-2 CEILING TRACK PLUG
AN, CM

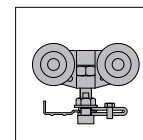

31-0600
LUMI TOP ROLLER

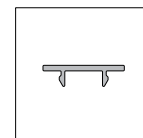

31-0895
AL31 MASKING STRIP 2750 MM
AN, CM

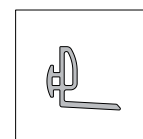

31-0922
AL31 DOOR FRAME GASKET
CZ, SJ

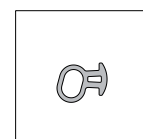

31-0923
AL31 DOOR FRAME CASING GASKET
CZ, SJ

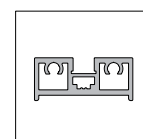

31-1300
AL31 DOOR PROFILE 3050 MM
AN, CM

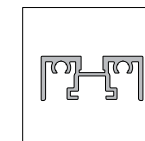

31-1310
AL31 OPEN RAIL 3050MM
AN, CM

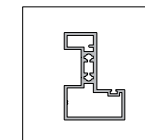

31-1320
AL31 DOOR FRAME 3050 MM
AN, CM

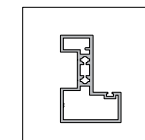

31-1321
AL31 DOOR FRAME 3550 MM
AN

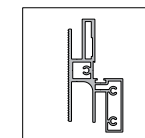

31-1322
AL31 DOOR FRAME 5300 MM
AN, CM

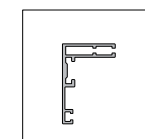

31-1603
AL31 DOOR FRAME CASING 30, 5300 MM
AN, CM

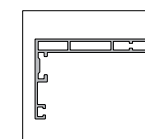

31-1607
AL31 DOOR FRAME CASING 70, 5300 MM
AN, CM

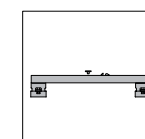

31-2691
LUMI AIR SPRING COMPONENTS

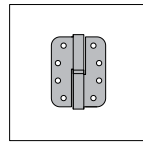

31-5141
AL31 BUTT HINGE, LEFT
CM, MS

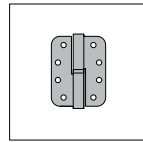

31-5142
AL31 BUTT HINGE, RIGHT
CM, MS

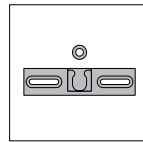

31-5143
LUMI DOOR LATCH

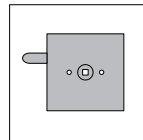

31-5144L
LUMI DOOR LOCK, LEFT
CM, MS

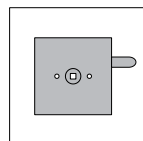

31-5144P
LUMI DOOR LOCK, RIGHT
CM, MS

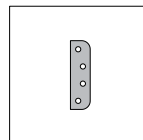

31-5145
BUTT HINGE SPACER
CM, MS

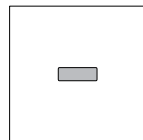

31-5210
LUMI FLAT BAR 12X4x3000 MM
AN, CM

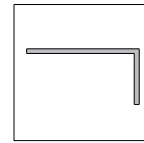

31-5220
LUMI ANGLE 50x25x4000 MM
AN, CM

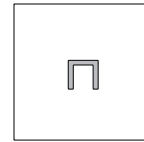

31-5240
LUMI C-CHANNEL BAR 12x12x3000 MM
AN, CM

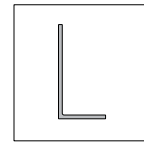

31-5250
LUMI FIXING BRACKET 50x25x2
AN, CM

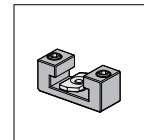

31-5251
LUMI ADJUSTMENT INSERT

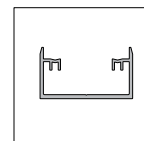

31-5252
LUMI C-CHANNEL BAR FOR ADJUSTMENT 4000 MM
AN, CM

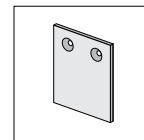

31-5253
MASKING PLATE OF LUMI ADJUSTABLE PANEL
MS, CM

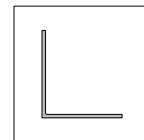

31-5260
LUMI DOOR CASING FIXING BRACKET 60x60x40

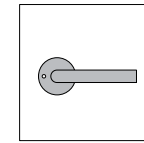

57-1300
LUMI DOOR HANDLE WITH ROUND PLATE
CM, MS

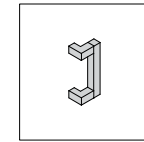

57-1305
LUMI HANDLE 160 MM
CM, MS

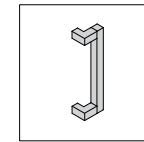

57-1309
LUMI HANDLE 288 MM
CM, MS

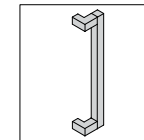

57-1314
LUMI HANDLE 448 MM
CM, MS

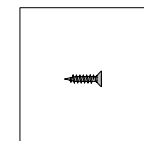

59-0702
MOUNTING SCREW 3,5x16 MM

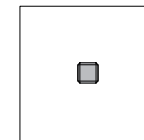

59-0719
HEADLESS SET SCREW M5x5

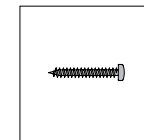

59-0728
MOUNTING SCREW 3,9x38 MM

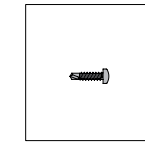

59-0730
CYLINDRICAL HEAD SELF DRILLING SCREW 3,5x16

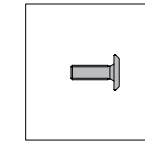

59-0731
SOCKET HEAD SCREW M6x18

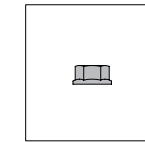

59-0732
SECURING NUT M6

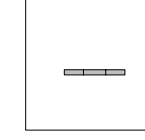

59-0733
6,4 MM PLAIN WASHER

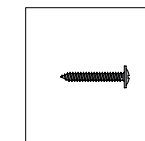

59-0739
SCREW WITH WASHER 3,5x25

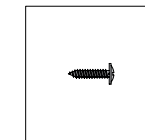

59-0740
SCREW WITH WASHER 3,5x13

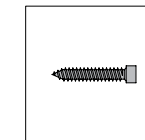

59-0749
MOUNTING SCREW 6,3x35

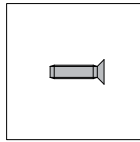

59-0751
COUNTERSUNK HEAD SELF-FORMING SCREW M5x10

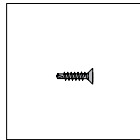

59-0758
COUNTERSUNK SELF DRILLING SCREW 3,5x16

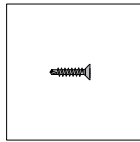

59-0759
COUNTERSUNK SELF DRILLING SCREW 3,5x19

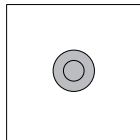

59-2002
SCREW PLUG
AN, CM

LUMI

LOFT STYLE DOOR AND GLAZING SYSTEM
ILLUMINATES, DIVIDES AND GIVES UNIQUE TWIST



1590 The Queensway
Toronto, Ontario
M8Z 1V1

416-533-4331
info@gemwindows.com